

BASS SLAMMER™

FEX10

Enclosure Volume: .6 Cubic Foot, Sealed

READ ALL DIRECTIONS CAREFULLY BEFORE BEGINNING

MOUNTING LOCATION: The enclosure mounts behind rear panel on passenger's side and replaces factory cargo net.

TOOLS FOR INSTALLATION:

Phillips Head Screwdriver

11/32" Socket

Ratchet

Panel Puller

15mm Wrench

T-50 Torx

6" Ratchet Extension

INSTALLATION: Follow the steps below

1. Place gasket provided around woofer hole cutout. Connect black wire to negative side of woofer and red wire to the positive side of woofer. Using screws provided install woofer into enclosure, making sure not to overtighten screws to avoid stripping.

2. Remove the retractable cargo cover.

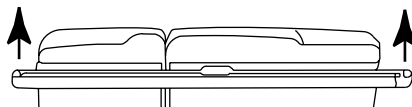

3. Remove the lift gate scuff plate, start from one end and pull up slowly working your way over the other side.

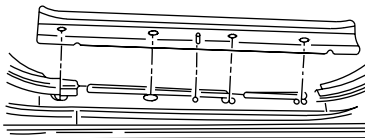

4. Pull back the cargo floor carpet and remove the three phillips head screws holding the trim panel to the floor.

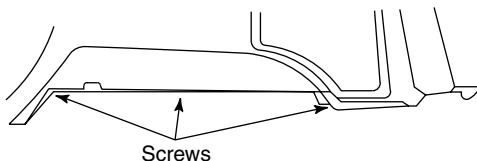

5. Remove the safety belt floor nut.

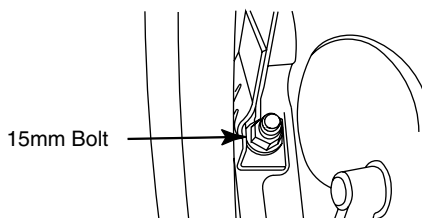

6. Unsnap and remove the safety belt bolt cover.

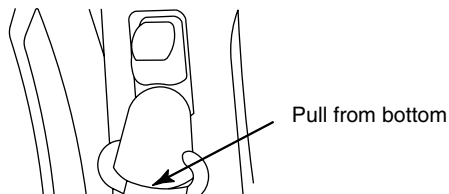

7. Remove the safety belt bolt.

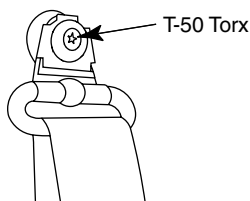

8. Remove passenger side door sill trim. Held into place by three clips. Pull slowly from the front, it will unsnap easily.

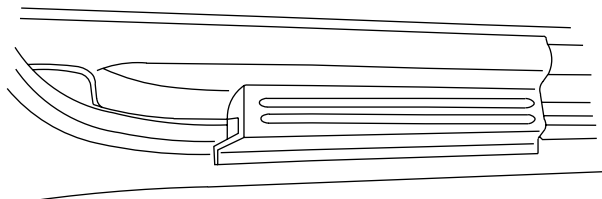

- Use a panel pulling tool to pull out plastic push pins in quarter panel trim. Older models have phillips head screws holding this panel on, remove them. Pull panel free from vehicle (be careful, it's a large piece take your time it will probably catch at the front). Thread the rear safety belt through the opening in the quarter trim panel.

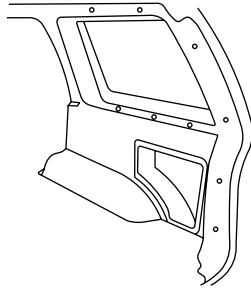

- If vehicle was equipped with factory amplified subwoofer system remove three 11/32" bolts holding it into place. Unplug amplifier and remove enclosure.
- Mount enclosure as shown below using the provided brackets.

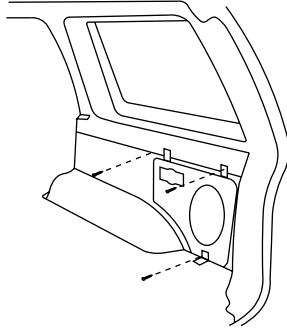

- To install grill into factory panel the cargo tray must be removed. Unsnap the nine white clips around the perimeter of the trim ring back. The trim ring along with the entire cargo tray assembly will come out the front. Retain the clips and tray you may want to replace it if you sell the vehicle.
- Install grill furnished, into the front of the panel into the location previously occupied by the trim ring. Using the 1/2" screws provided, screw grill from back through the factory slots in the panel.
- Make speaker connections to the enclosure from the amplifier, loosen terminal knobs (a 13mm nut driver can be used). Connect speaker wires from amplifier to enclosure, positive to red terminal knob and negative to black terminal knob.
- Check all connections and mountings one last time to ensure the enclosure is operational before reattaching panels.
- Reinstall quarter panel trim. Making sure to thread seat belt through the opening in quarter panel trim.
- Reinstall push pins, seat belt and threshold trim.

FACTORY SPEAKER WIRE COLORS

The drivers side rear speaker wires are located under the threshold. Colors are left side, orange/red (positive), brown/pink (negative).

The passengers side rear speakers are located under the threshold. Colors are right side, gray/light blue (positive), tan/yellow (negative).

Although every effort has been made to assure proper wiring color, Mitek is not responsible for any changes made by the vehicle manufacturer which sometime occur. If wiring colors do not match then physical verification is required. These instructions are guidelines only and in no way are intended to replace a professional installation. As always before screwing and drilling check to make sure you will not damage wires, hoses or cause damage to the vehicle.

MAXIMUM ENCLOSURE MOUNTING SPECIFICATIONS

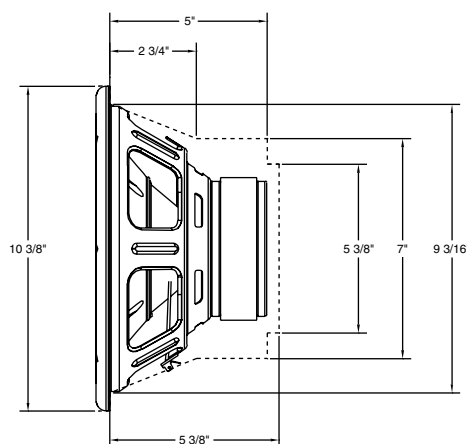

**MAXIMIZE YOUR SYSTEM'S
PERFORMANCE**

streetwires.com

STREETWIRES®